

Switches and Accessories JN DC Contactor Energy Saver

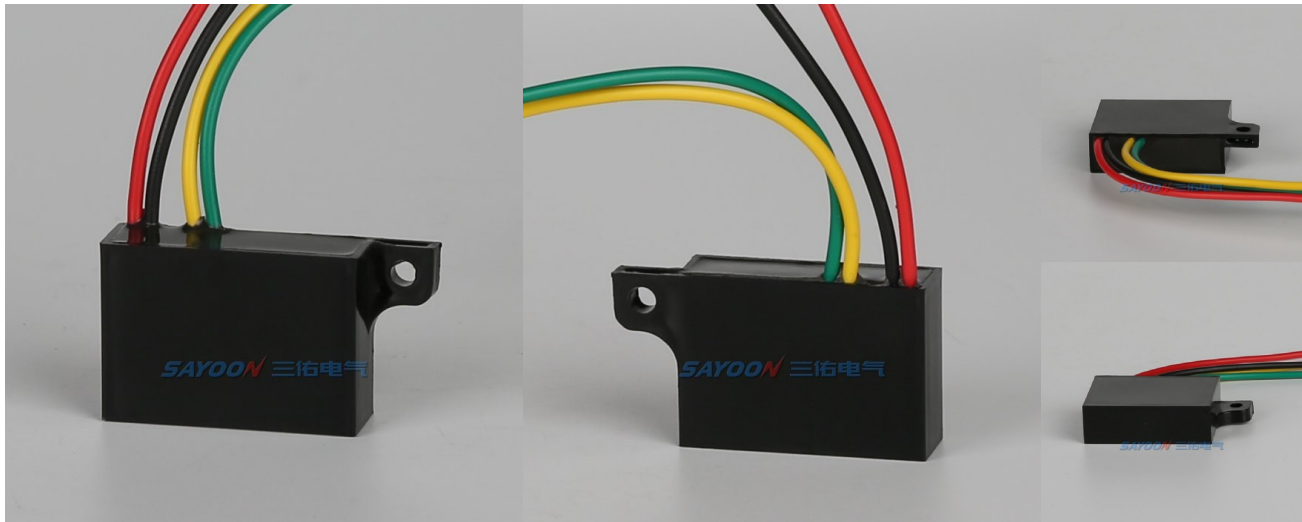

USES

It is used for DC contactor to save energy, which can reduce the operating temperature of the contactor and reduce the energy consumption of the DC contactor.

<u>JN</u>	<u>-12</u>	<u>-20</u>	<u>-A</u>
1	2	3	4

- 1 Product type
- 2 The coil voltage connecting the contactor
- 3 Percentage of energy conservation and power consumption
- 4 Type of connector for contact: A UT4(4mm); B 6.3Insert spring

ORDER FORM DESCRIPTION

Note when ordering: the product shall not be used at the starting current exceeding the rated current of the energy saver. The contactor with double coil shall not be used, but only the contactor with single coil. If the user needs, please place a special order.

TECHNICAL PARAMETERS

(Version 1.38)

SAYOON Product Type	JN
Rated current	3A
Rated voltage	12V,24V,36V,48V,60V,72V
Input Terminal	Red: positive power input, black: negative power supply
Output Terminal (Connecting contactor)	Yellow: positive output, Green: negative power supply
Input line length	320mm
Output line length	150mm
Output interface	UT4 (4mm)
Wire specification	RV-0.3
Save power and consumption	70-95%

INSTALLATION DIAGRAM

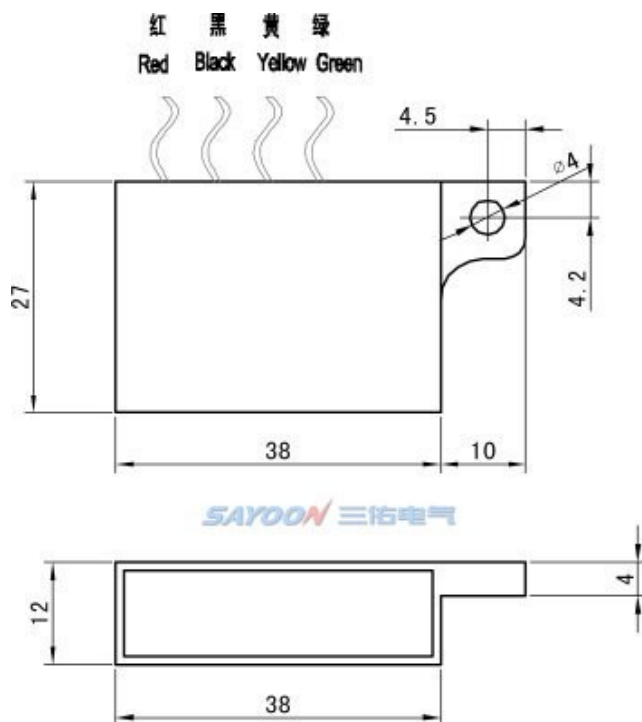

■ WIRING DIAGRAM

